

referência / reference

peso embalagem / weight pack

embalagem / pack

897

7,00 kg

12

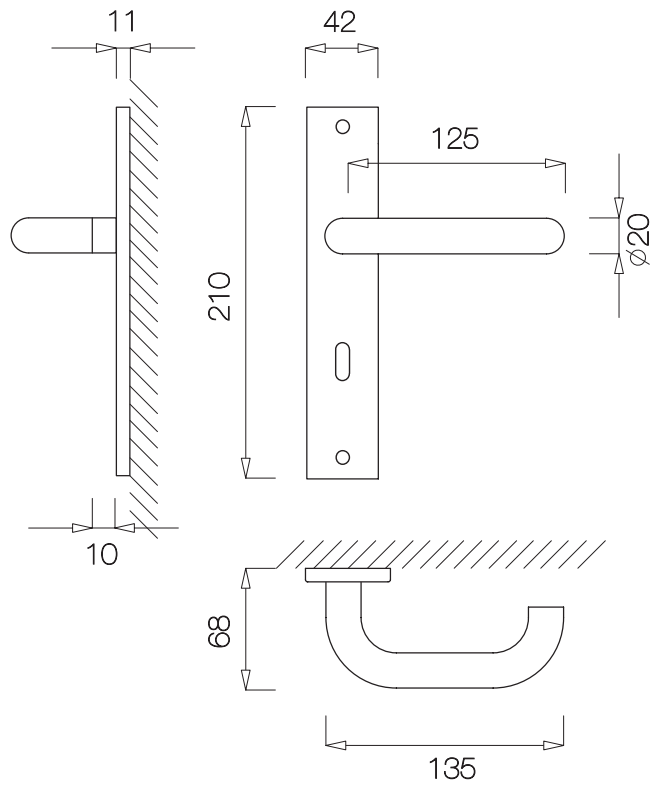

aço inox satinado
 satin stainless steel
 (16)